

#### Features

- Single-speed whirlpool offers performance and value with 8 fully adjustable jets.
- Hydromassage flow and direction can be controlled at each jet.
- Built-in heater.
- Comfort Depth® design offers a convenient 19" step-over height while retaining the same depth as a standard 21" bath.
- Generous length provides a spacious bathing area.
- Integral lumbar support.
- Slotted overflow allows for deep soaking.
- Textured bottom surface.
- Coordinates with other products in the Archer collection.

#### Material

- Acrylic.

#### Hydrotherapy

- Whirlpool.

#### Installation

- Reversible drain.
- Drop-in.

#### Required Products/Accessories

K-7271 Brass Slotted Overflow Bath Drain

or

K-7272 PVC Slotted Overflow Bath Drain

#### Recommended Products/Accessories

K-9529 Removable Bath Seat

K-24916 Wireless Music Kit

K-23726 Drain treatment

K-23732 Tub & shower cleaner



ADA

#### Codes/Standards

ASME A112.19.7/CSA B45.10

CSA B45.5/IAPMO Z124

ASTM E162

ASTM E662

UL 1795

ADA







ICC/ANSI A117.1

**KOHLER® Plastic Baths and Receptors Lifetime Limited Warranty**  
**KOHLER® Hydrotherapy Components Five-Year Limited Warranty**

See website for detailed warranty information.

#### Available Colors/Finishes

*Color tiles intended for reference only.*

Color	Code	Description
	0	White
	96	Biscuit
	NY	Dune
	95	Ice™ Grey
	58	Thunder™ Grey
	7	Black Black™

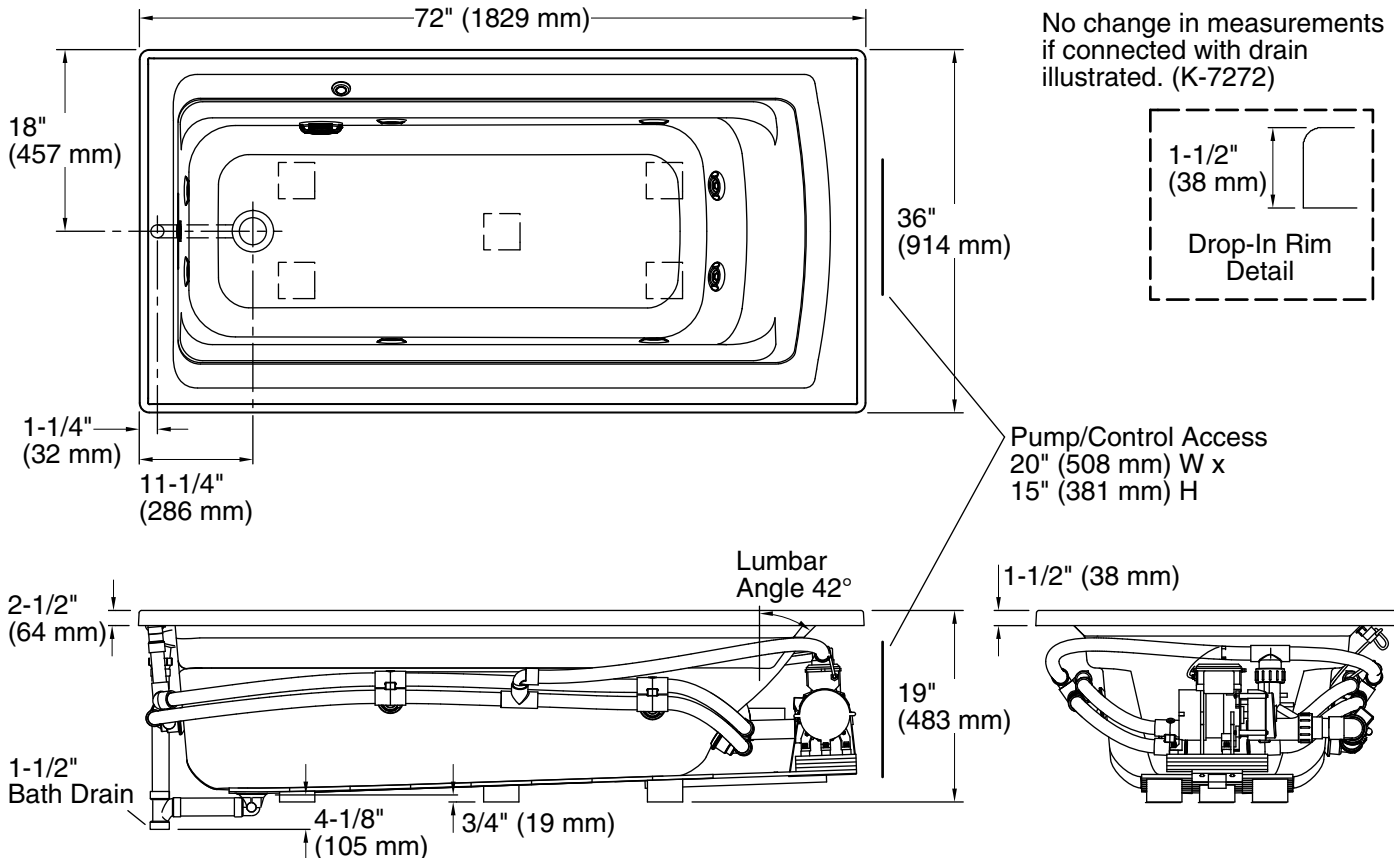

### Required Electrical Service

Two dedicated circuits required, protected with Class A Ground-Fault Circuit-Interrupter (GFCI). Outside North America, this device may be known as a Residual Current Device (RCD).

Pump: 120 V, 15 A, 60 Hz  
Heater: 120 V, 15 A, 60 Hz

### Technical Information

All product dimensions are nominal.

Installation: Drop-in  
Drain location: End  
Basin area, bottom: 51-3/8" x 21" (1305 mm x 533 mm)  
Basin area, top: 64-1/2" x 30-1/2" (1638 mm x 775 mm)  
Weight: 110 lbs (49.9 kg)  
Minimum floor load: 41 lbs/ft<sup>2</sup> (200.2 kg/m<sup>2</sup>)  
Water depth: 15" (381 mm)  
Water capacity: 72 gal (272.5 L)  
Cutout: Drop-in, 70-1/2" x 34-1/2" (1791 mm x 876 mm)  
Electrical component rating: Pump: 120 V, 7 A, 60 Hz  
Heater: 120 V, 12.5 A, 60 Hz, 1500 W  
Pump speed: Single

### Notes

Measure your actual product for rough-in details.

Install this product according to the installation instructions.

The hot water supply should be 70% of the capacity of the bath or greater. Installations will vary.

This product is designed for drop-in installation only. It is not suited for use in a three-wall alcove with an overhead shower.

ADA compliant when installed to the specific requirements of these regulations.